

TOSHIBA InGaAlP LED

TLRE62T,TLRME62T,TLSE62T,TLOE62T,LYE62T, TLPYE62T,TLGE62T,TLFGE62T,TLPGE62T

Panel Circuit Indicators

- $\phi 3$ mm package
- InGaAlP technology
- All plastic mold type
- Transparent lens
- Line-up: 6 colors (red, orange, yellow, pure yellow, green and pure green)
- High intensity light emission
- Excellent low current light output
- Applications: message boards, security devices and dashboard displays

Line-up

Product Name	Color	Material
TLRE62T	Red	InGaAlP
TLRME62T	Red	
TLSE62T	Red	
TLOE62T	Orange	
TYE62T	Yellow	
TLPYE62T	Pure Yellow	
TLGE62T	Green	
TLFGE62T	Green	
TLPGE62T	Pure Green	

Unit: mm

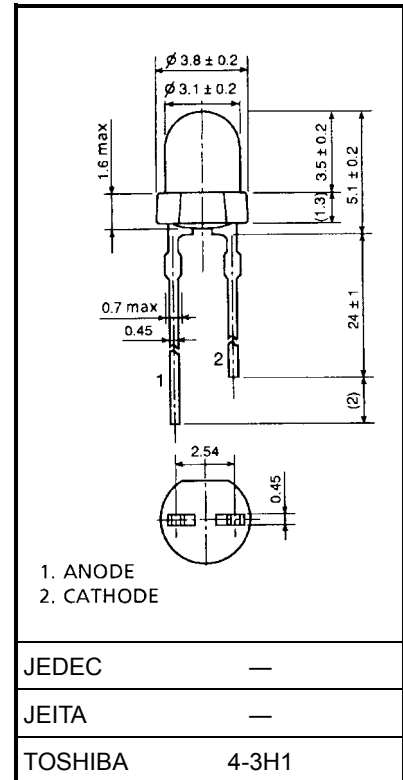

Weight: 0.14 g

Maximum Ratings (Ta = 25°C)

Product Name	Forward Current I _F (mA)	Reverse Voltage V _R (V)	Power Dissipation P _D (mW)	Operating Temperature T _{opr} (°C)	Storage Temperature T _{stg} (°C)
TLRE62T	50	4	120	-40~100	-40~120
TLRME62T	50	4	120		
TLSE62T	50	4	120		
TLOE62T	50	4	120		
TLYE62T	50	4	120		
TLPYE62T	50	4	120		
TLGE62T	50	4	120		
TLFGE62T	50	4	120		
TLPGE62T	50	4	120		

Electrical and Optical Characteristics (Ta = 25°C)

Product Name	Typ. Emission Wavelength				Luminous Intensity I _V			Forward Voltage V _F			Reverse Current I _R	
	λ _d	λ _p	Δλ	I _F	Min	Typ.	I _F	Typ.	Max	I _F	Max	V _R
TLRE62T	630	(644)	20	20	47.6	120	20	1.9	2.4	20	50	4
TLRME62T	626	(636)	23	20	47.6	180	20	1.9	2.4	20	50	4
TLSE62T	613	(623)	20	20	85	200	20	1.9	2.4	20	50	4
TLOE62T	605	(612)	20	20	153	350	20	2.0	2.4	20	50	4
TLYE62T	587	(590)	17	20	85	250	20	2.0	2.4	20	50	4
TLPYE62T	580	(583)	14	20	47.6	150	20	2.0	2.4	20	50	4
TLGE62T	571	(574)	17	20	47.6	110	20	2.0	2.4	20	50	4
TLFGE62T	565	(568)	15	20	27.2	70	20	2.0	2.4	20	50	4
TLPGE62T	558	(562)	14	20	15.3	45	20	2.1	2.4	20	50	4
Unit	nm			mA	mcd		mA	V		mA	μA	V

Precautions

Please be careful of the following:

- Soldering temperature: 260°C max, soldering time: 3 s max
(soldering portion of lead: up to 2 mm from the body of the device)
- If the lead is formed, the lead should be formed up to 5 mm from the body of the device without forming stress to the resin. Soldering should be performed after lead forming.
- This visible LED lamp also emits some IR light.
If a photodetector is located near the LED lamp, please ensure that it will not be affected by this IR light.

TLRE62T

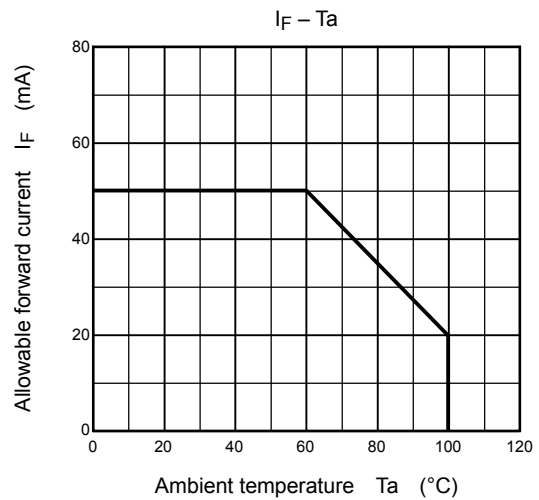
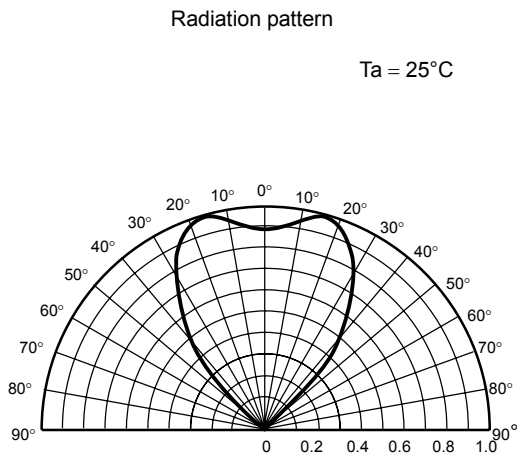
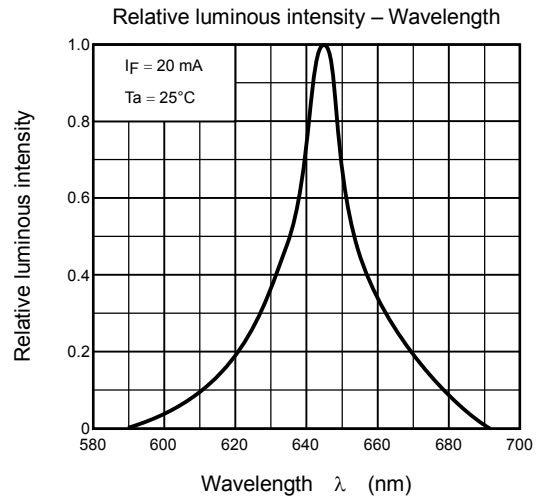
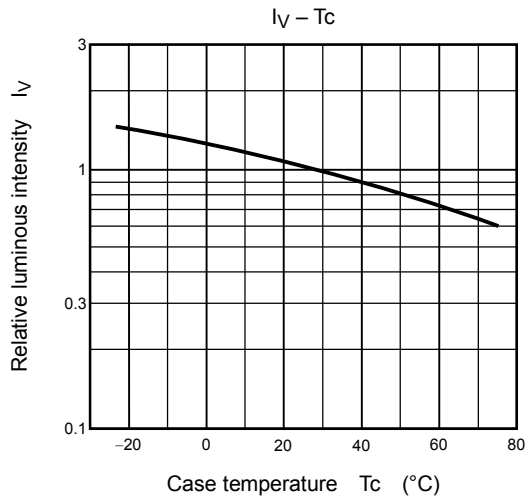
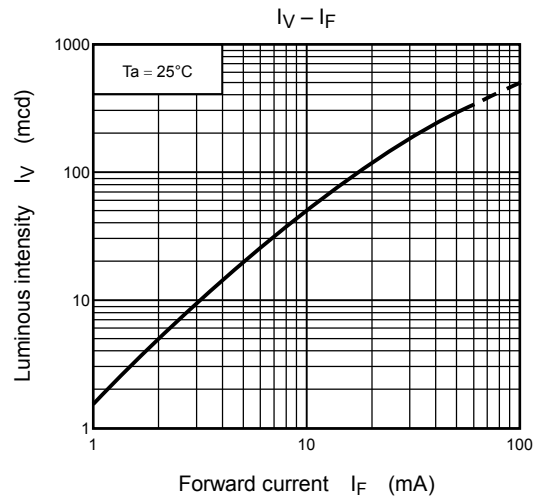
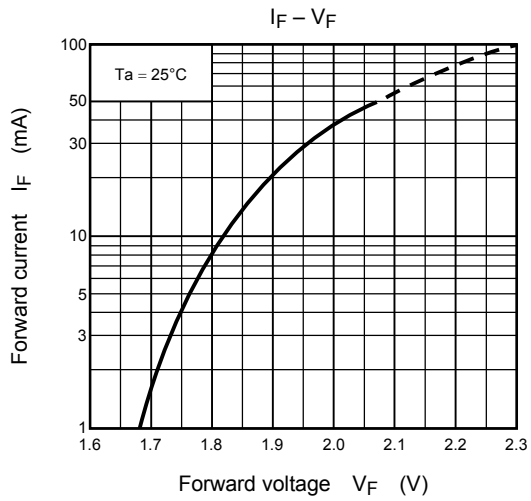

TLRME62T

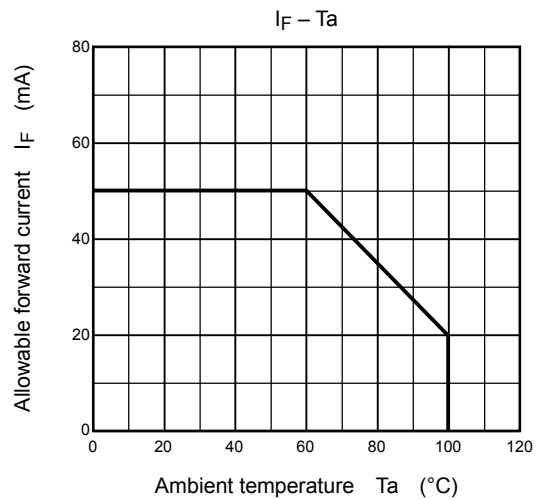
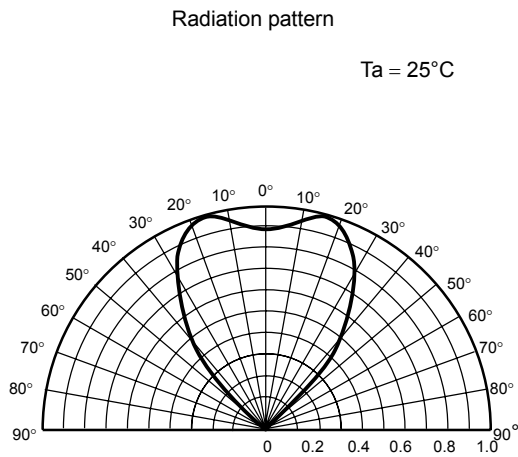
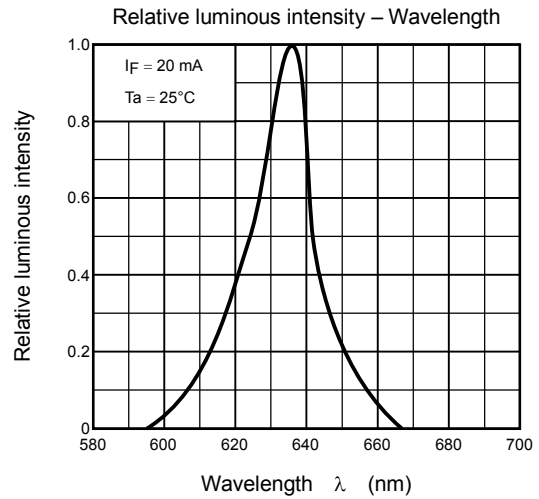
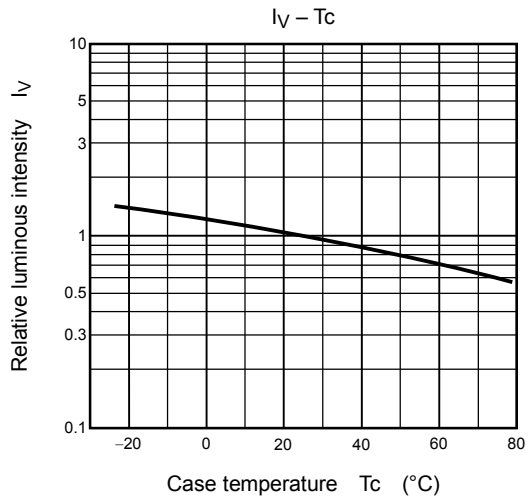
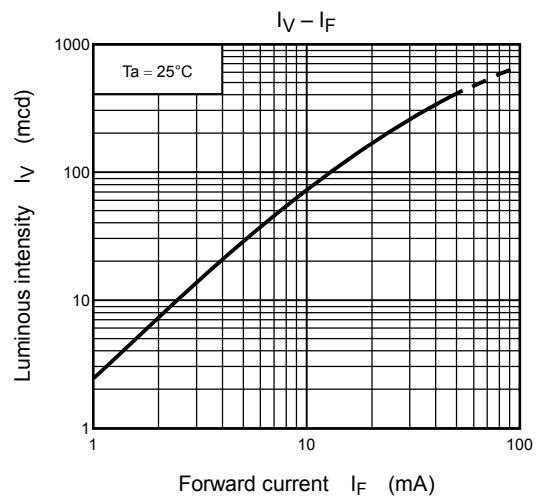
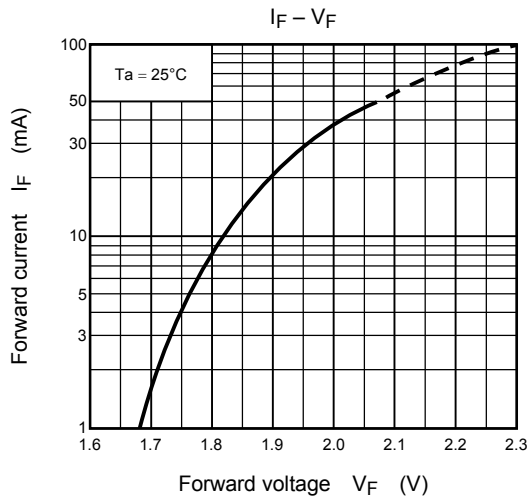

TLSE62T

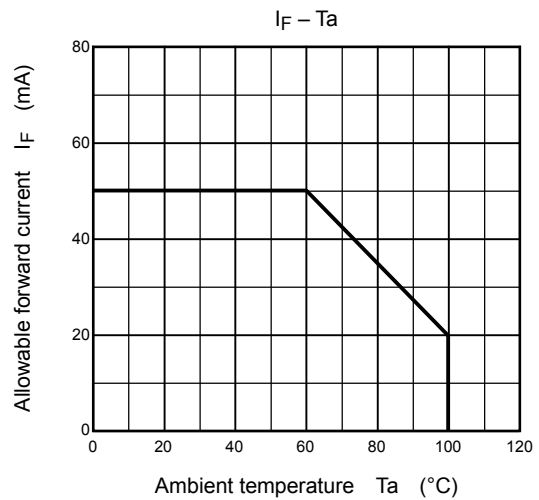
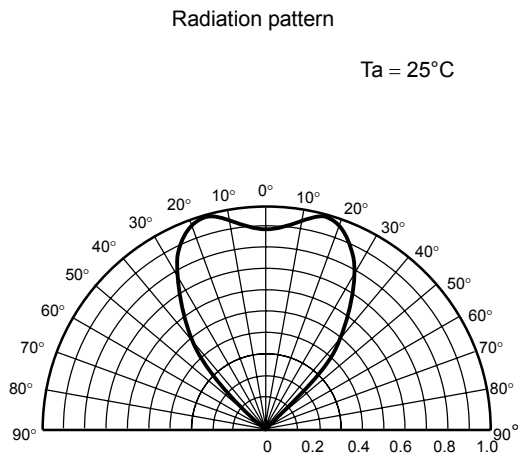
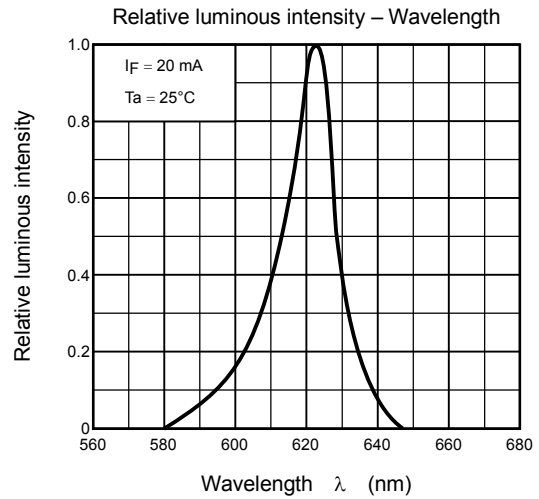
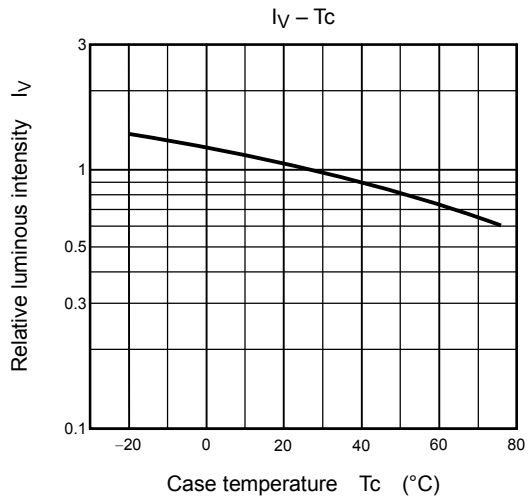
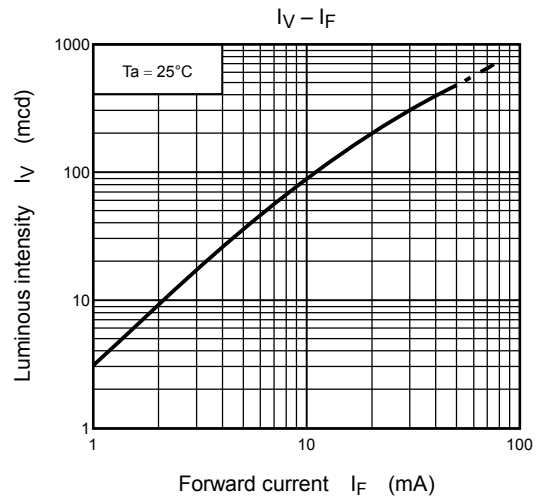
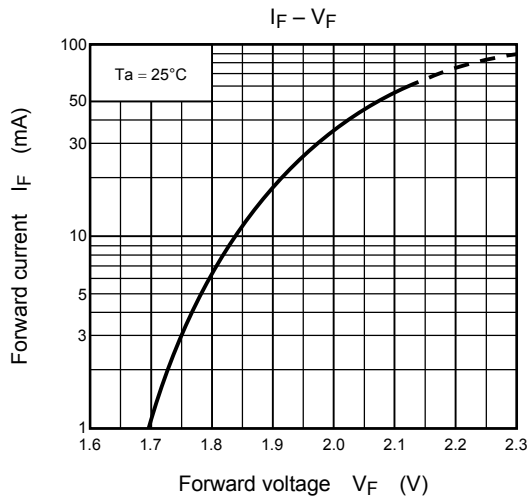

TLOE62T

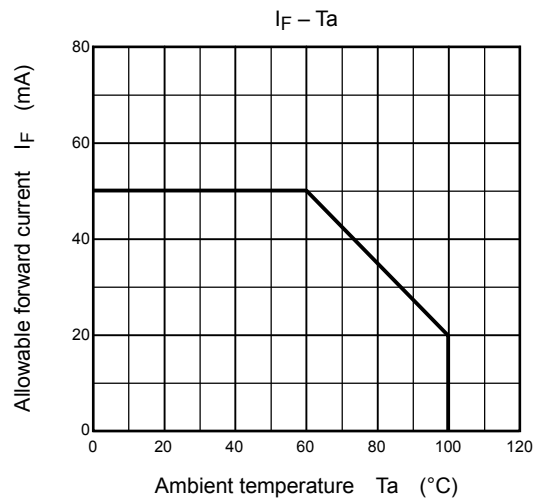
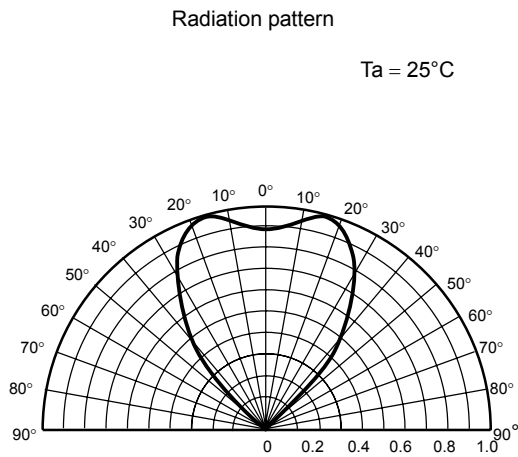
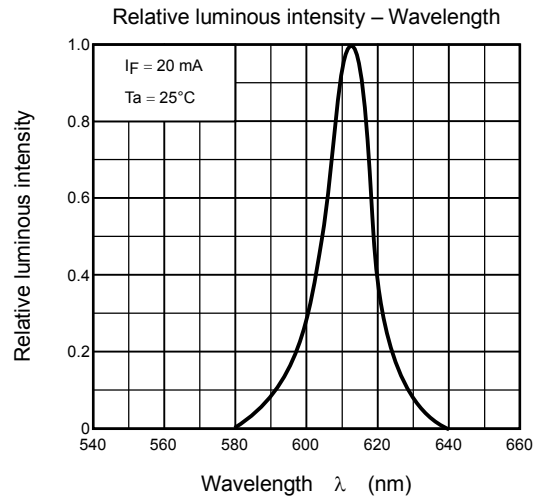
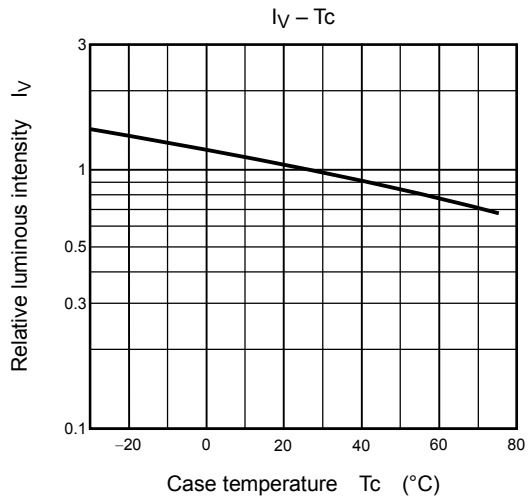
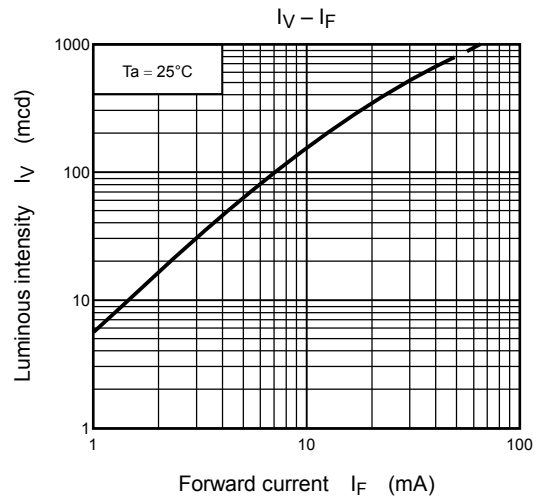
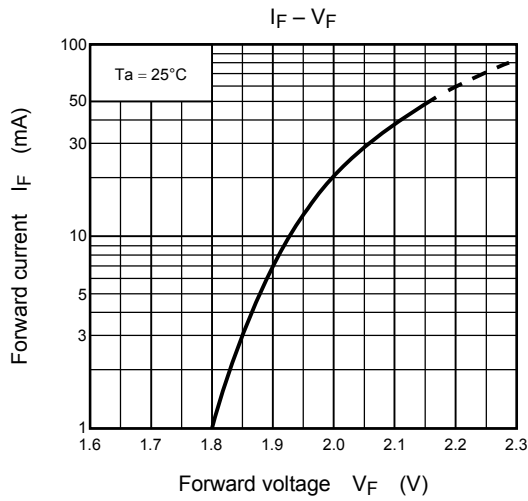

TLYE62T

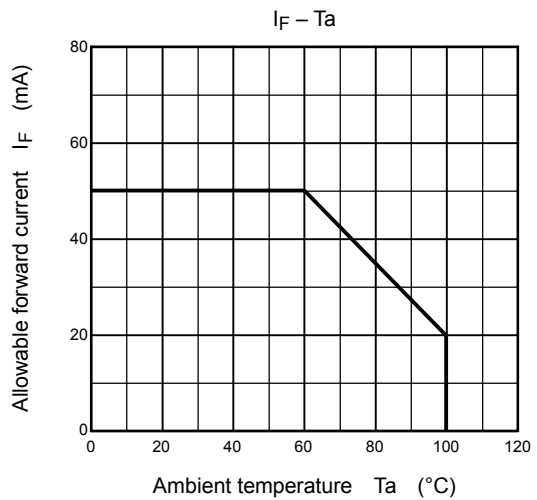
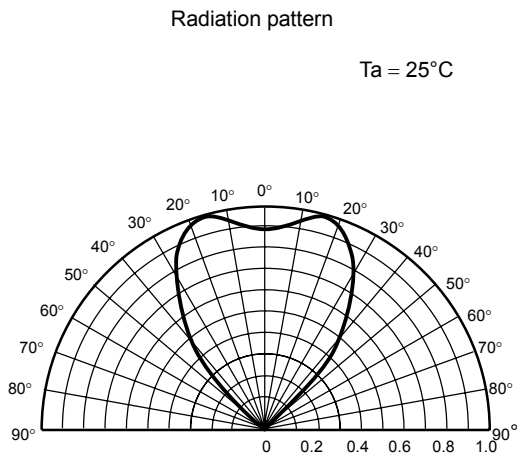
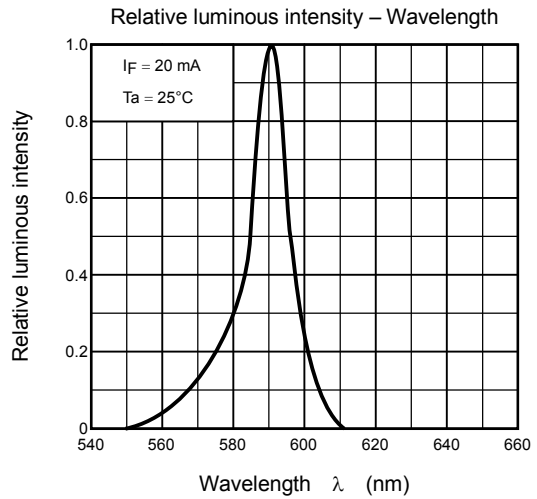
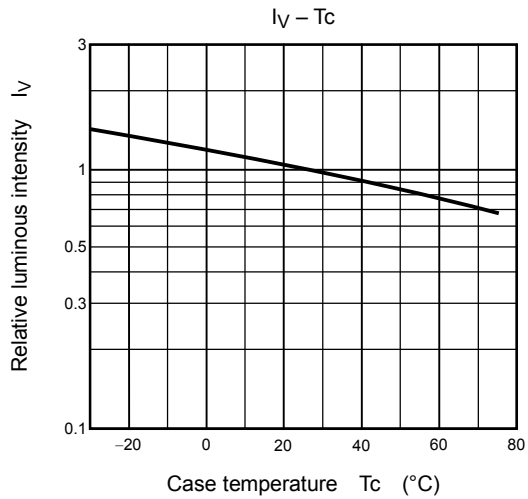
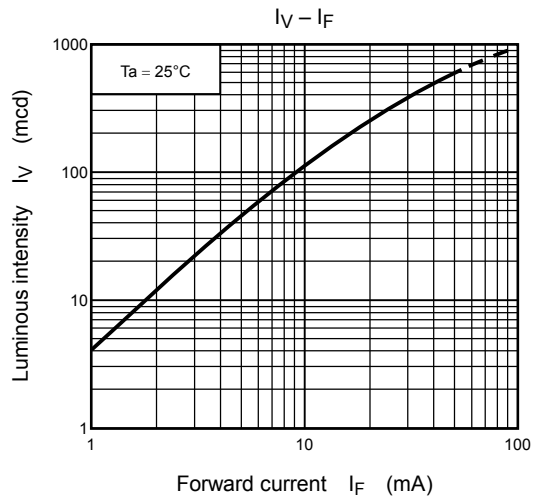
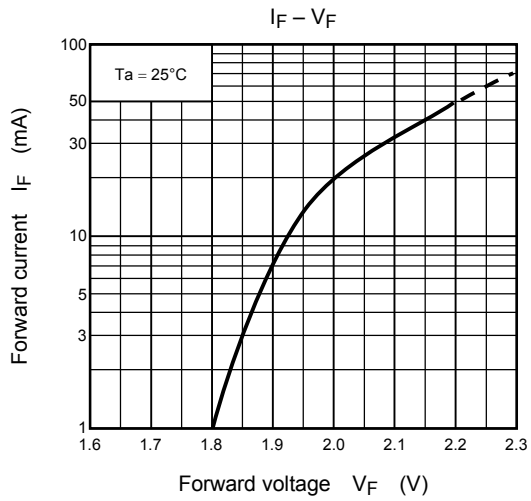

TLPYE62T

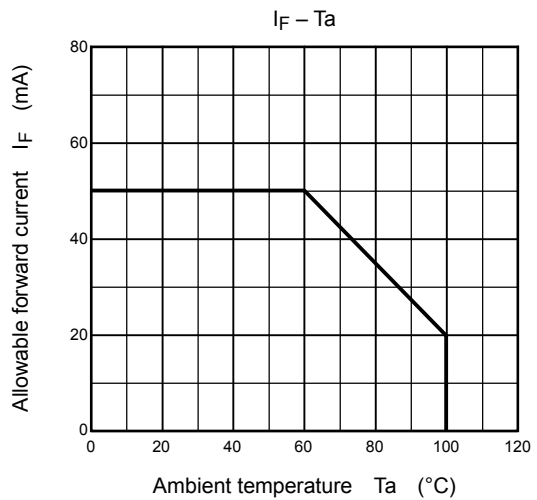
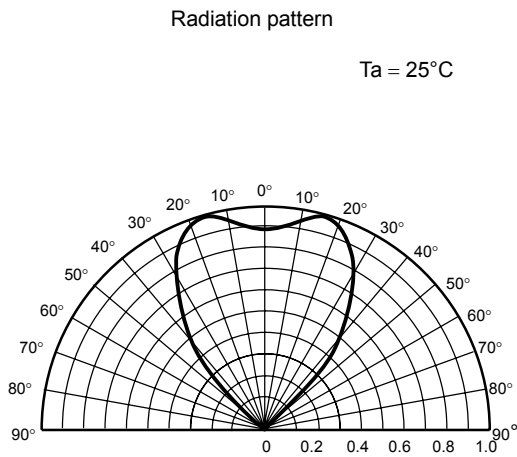
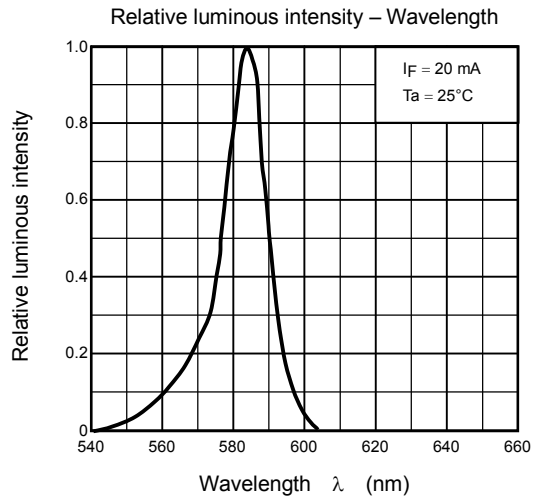
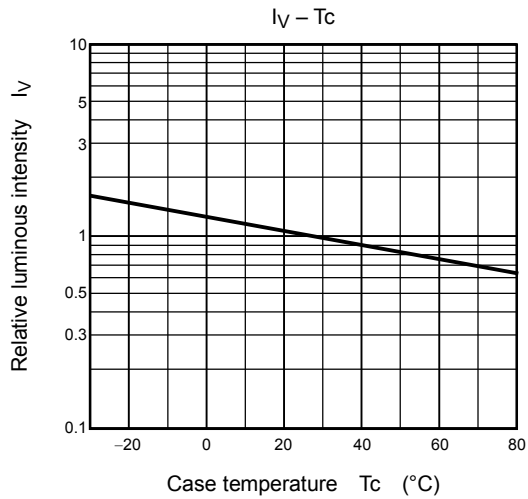
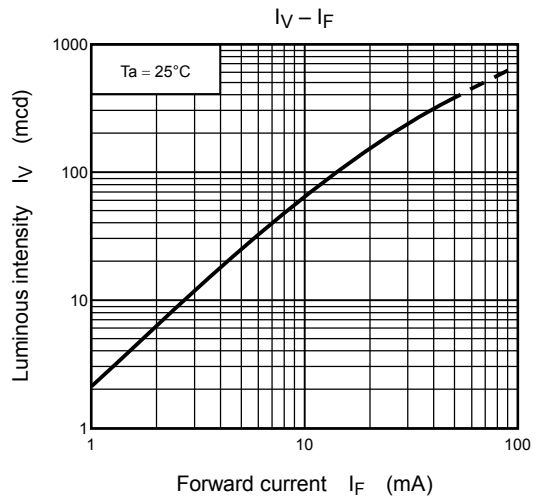
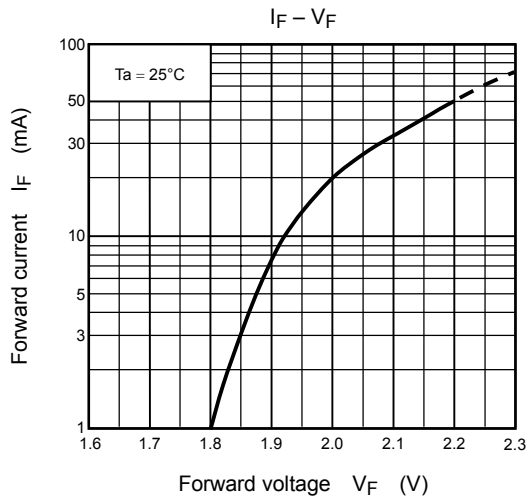

TLGE62T

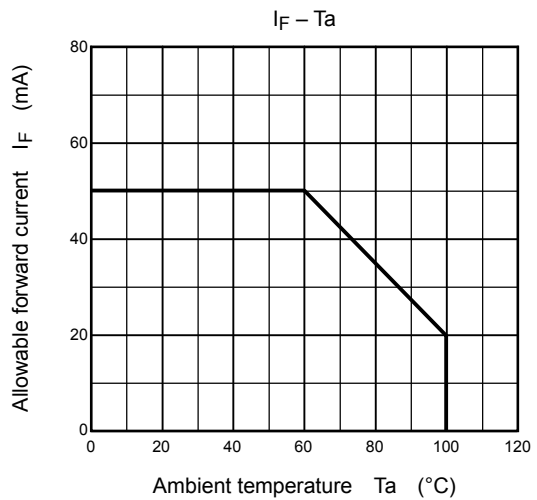
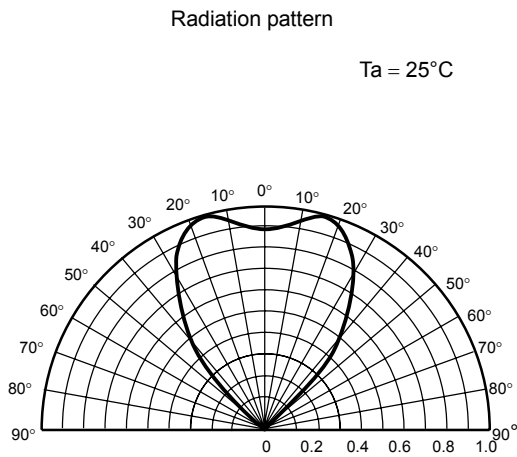
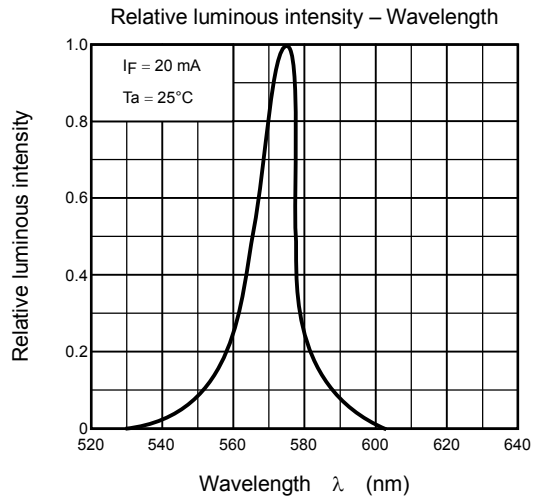
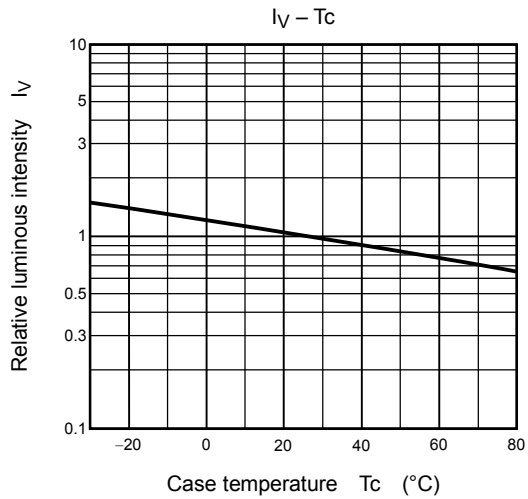
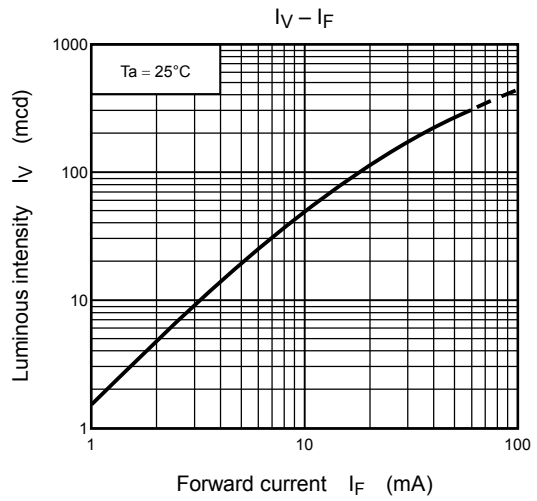
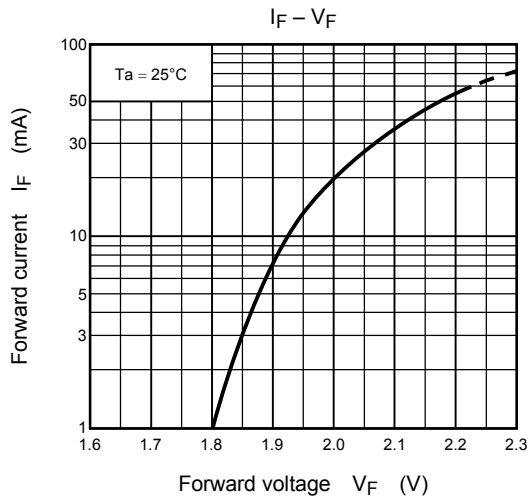

TLFGE62T

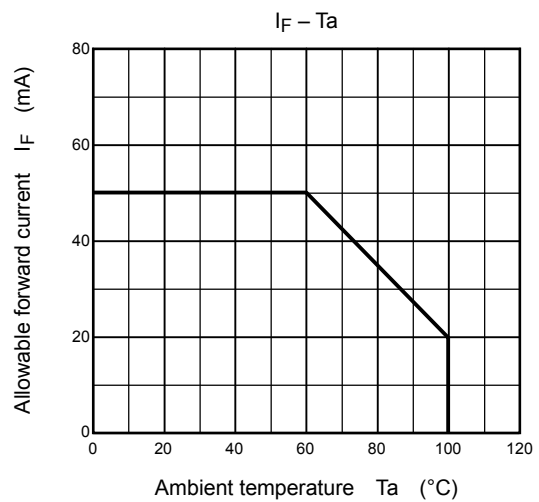
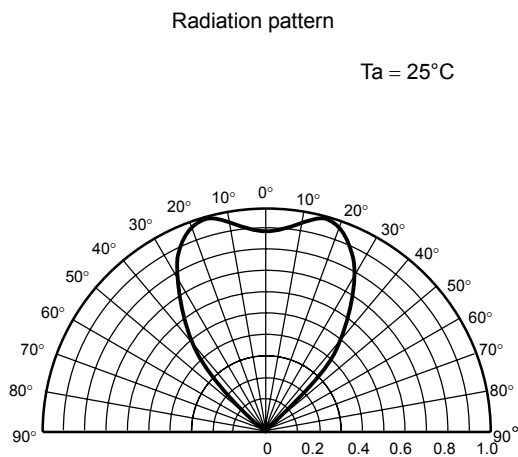
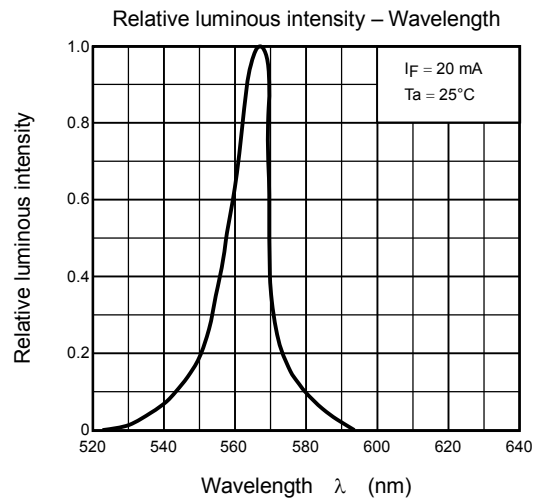
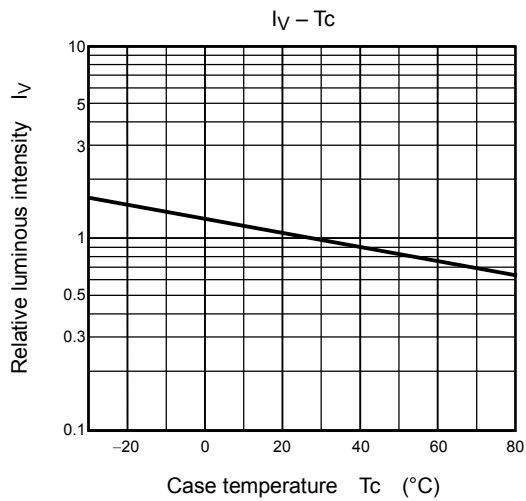
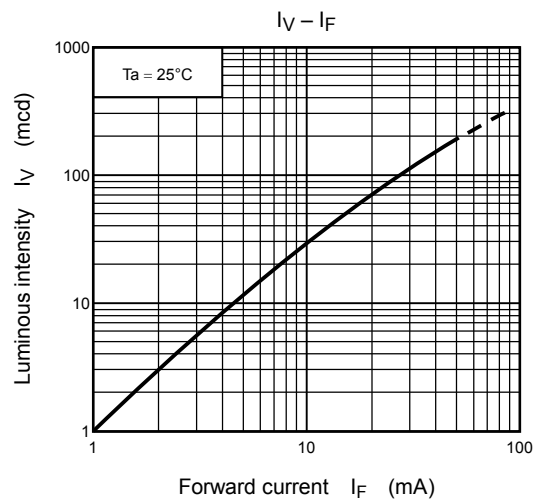
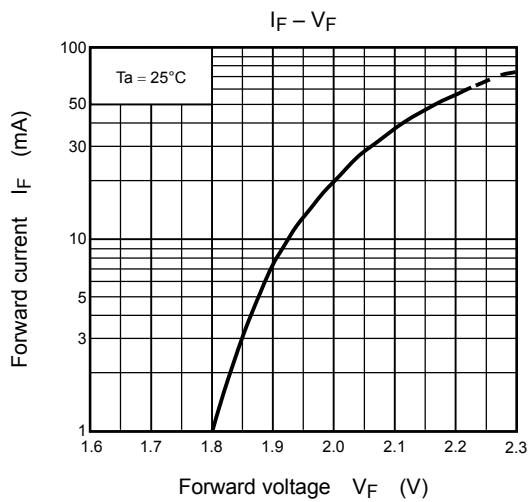

TLPGE62T

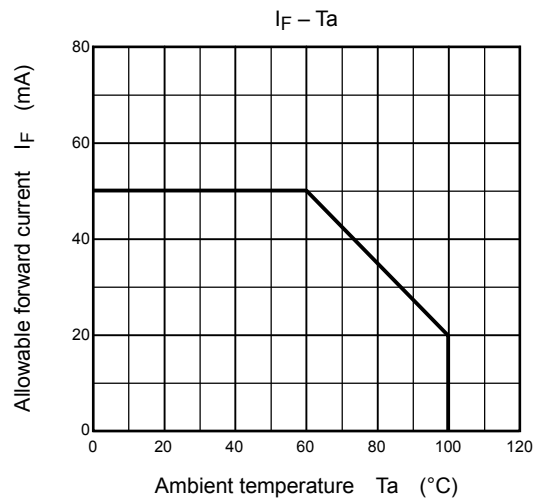
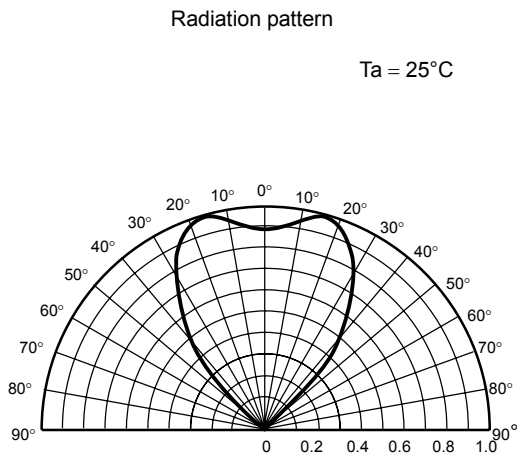
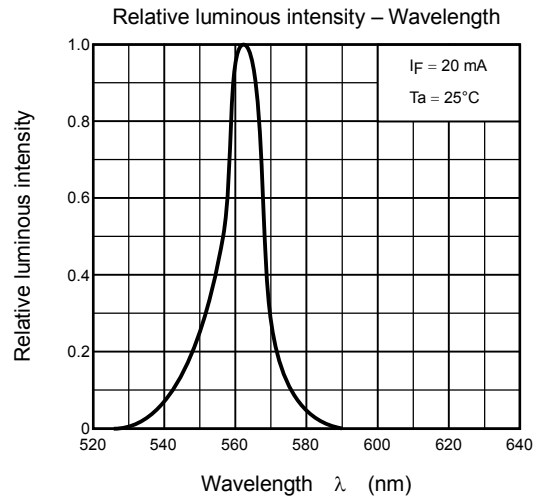
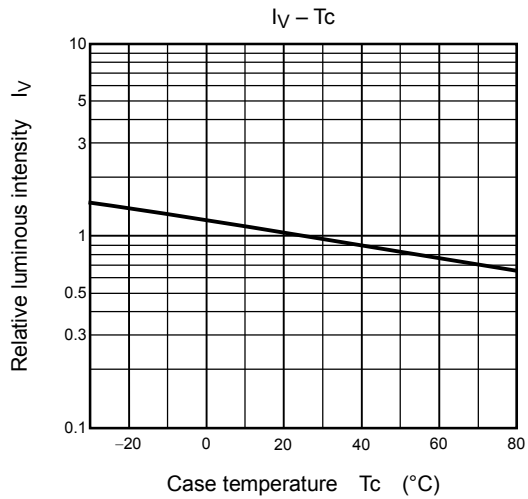
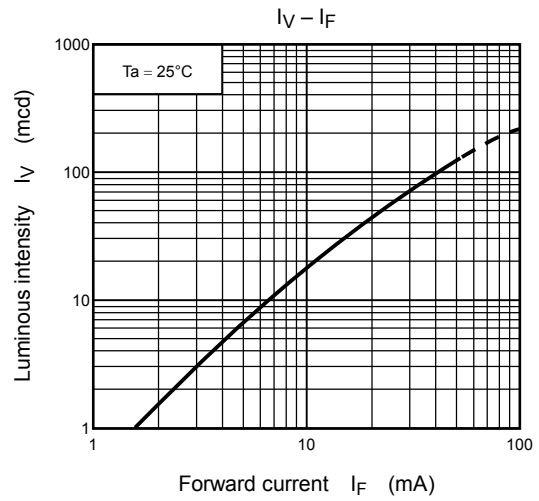
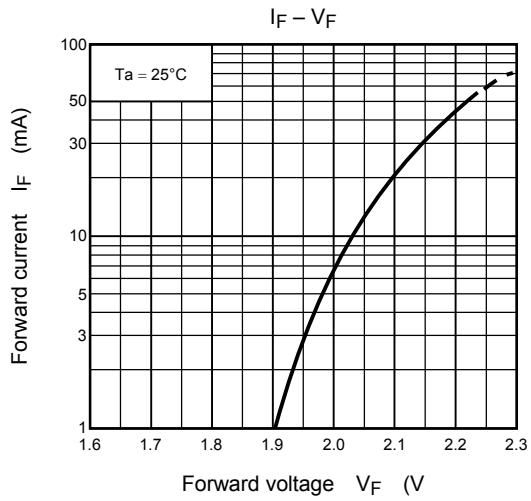

RESTRICTIONS ON PRODUCT USE

000707EAC

- TOSHIBA is continually working to improve the quality and reliability of its products. Nevertheless, semiconductor devices in general can malfunction or fail due to their inherent electrical sensitivity and vulnerability to physical stress. It is the responsibility of the buyer, when utilizing TOSHIBA products, to comply with the standards of safety in making a safe design for the entire system, and to avoid situations in which a malfunction or failure of such TOSHIBA products could cause loss of human life, bodily injury or damage to property.
In developing your designs, please ensure that TOSHIBA products are used within specified operating ranges as set forth in the most recent TOSHIBA products specifications. Also, please keep in mind the precautions and conditions set forth in the "Handling Guide for Semiconductor Devices," or "TOSHIBA Semiconductor Reliability Handbook" etc..
- The TOSHIBA products listed in this document are intended for usage in general electronics applications (computer, personal equipment, office equipment, measuring equipment, industrial robotics, domestic appliances, etc.). These TOSHIBA products are neither intended nor warranted for usage in equipment that requires extraordinarily high quality and/or reliability or a malfunction or failure of which may cause loss of human life or bodily injury ("Unintended Usage"). Unintended Usage include atomic energy control instruments, airplane or spaceship instruments, transportation instruments, traffic signal instruments, combustion control instruments, medical instruments, all types of safety devices, etc.. Unintended Usage of TOSHIBA products listed in this document shall be made at the customer's own risk.
- Gallium arsenide (GaAs) is a substance used in the products described in this document. GaAs dust and fumes are toxic. Do not break, cut or pulverize the product, or use chemicals to dissolve them. When disposing of the products, follow the appropriate regulations. Do not dispose of the products with other industrial waste or with domestic garbage.
- The information contained herein is presented only as a guide for the applications of our products. No responsibility is assumed by TOSHIBA CORPORATION for any infringements of intellectual property or other rights of the third parties which may result from its use. No license is granted by implication or otherwise under any intellectual property or other rights of TOSHIBA CORPORATION or others.
- The information contained herein is subject to change without notice.